

PORTASPAZZOLE PER FUNZIONAMENTO IN OLIO
Serie SPL

BRUSHOLDERS FOR WET RUNNING
Model SPL

DIMENSIONI • DIMENSIONS

tipo - size	A	B	C	D	E	F
SPL 0	62	40	12	17	M14 x 1,5	4
SPL 1	52	40	12	19	M16 x 1,5	6
SPL 2	60	40	20	19	M16 x 1,5	6
SPL 3	68	40	28	19	M16 x 1,5	6
SPL 4	88	40	48	19	M16 x 1,5	6
SPL 5	108	40	68	19	M16 x 1,5	6
SPL 6	138	40	98	19	M16 x 1,5	6
SPL 7	70	50	20	22	M18 x 1,5	8
SPL 8	78	50	28	22	M18 x 1,5	8
SPL 9	98	50	48	22	M18 x 1,5	8
SPL 10	118	50	68	22	M18 x 1,5	8
SPL 11	148	50	98	22	M18 x 1,5	8

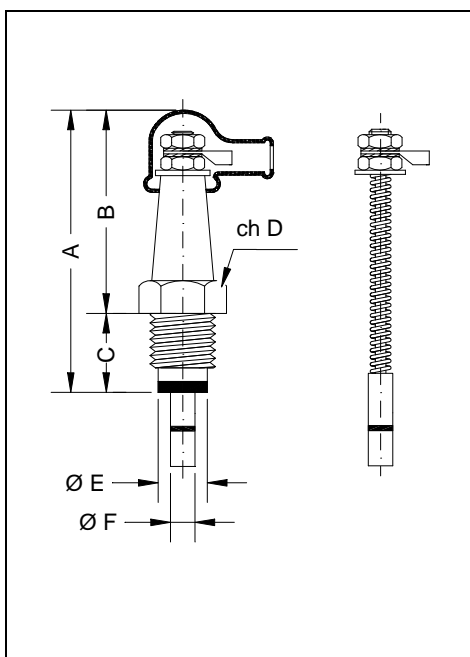

PORTASPAZZOLE PER FUNZIONAMENTO A SECCO
Serie SPS

BRUSHOLDERS FOR DRY RUNNING
Model SPS

DIMENSIONI • DIMENSIONS

tipo - size	A	B	C	D	E	F
SPS 0	62	40	12	17	M14 x 1,5	4
SPS 1	52	40	12	19	M16 x 1,5	8
SPS 2	60	40	20	19	M16 x 1,5	8
SPS 3	68	40	28	19	M16 x 1,5	8
SPS 4	88	40	48	19	M16 x 1,5	8
SPS 5	108	40	68	19	M16 x 1,5	8
SPS 6	138	40	98	19	M16 x 1,5	8
SPS 7	70	50	20	22	M18 x 1,5	8
SPS 8	78	50	28	22	M18 x 1,5	8
SPS 9	98	50	48	22	M18 x 1,5	8
SPS 10	118	50	68	22	M18 x 1,5	8
SPS 11	148	50	98	22	M18 x 1,5	8

MONTAGGIO • MOUNTING

